

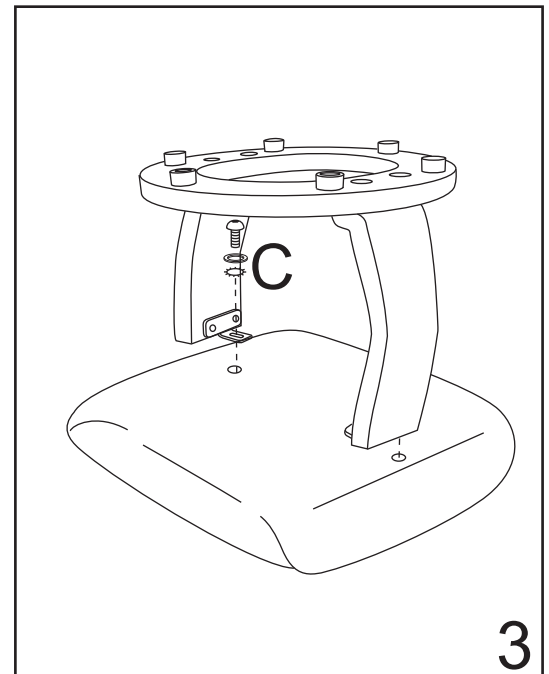

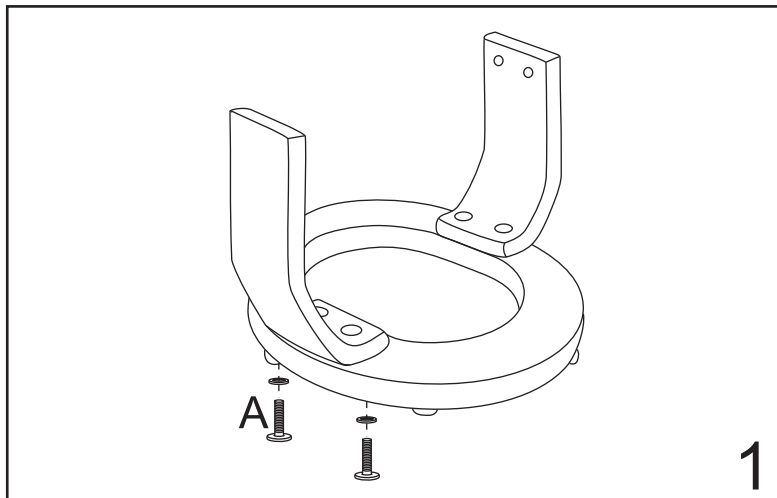

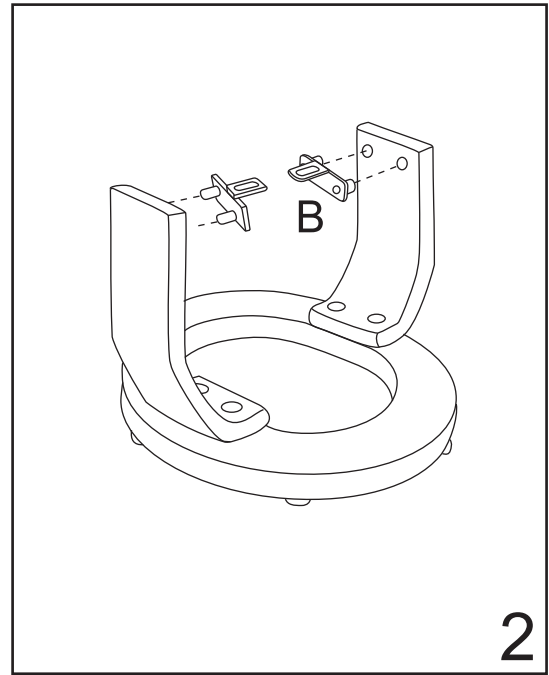

7651

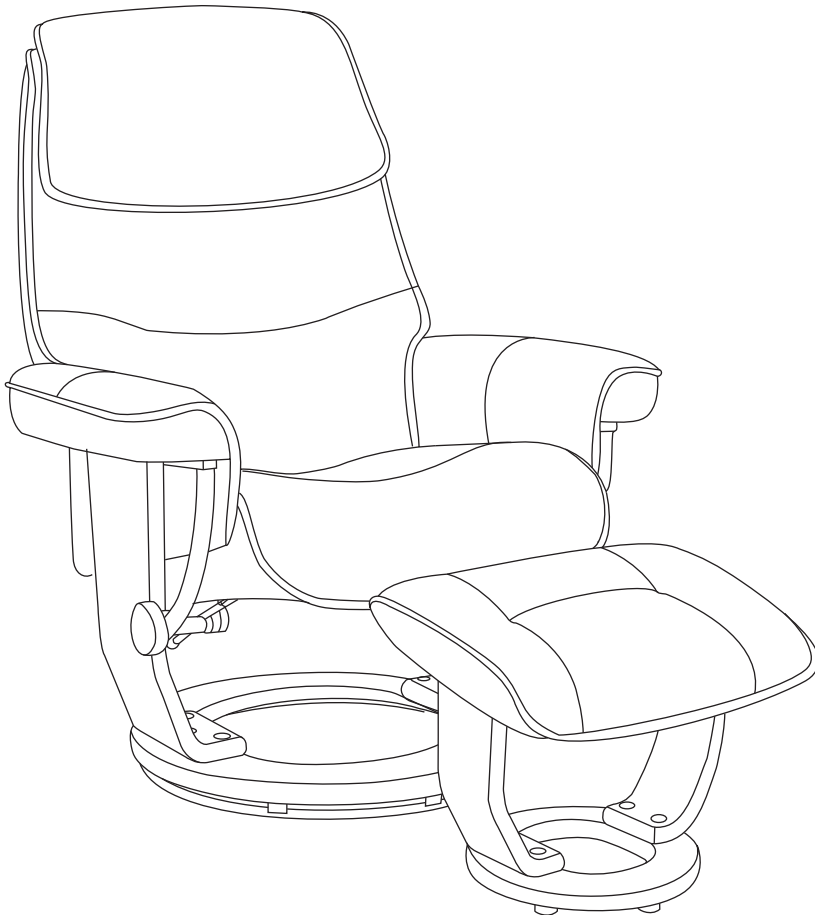
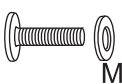

DURING ASSEMBLY CHECK AND TIGHTEN ALL BOLTS

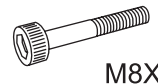
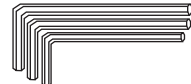
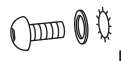
A	 M8X38	4 PCS	D	 M8X35	2 PCS	G	 M6X25	4 PCS
B		2 PCS	E	 M8X65	2 PCS	H		1 SET
C	 M6X20	2 PCS	F		1 PC			

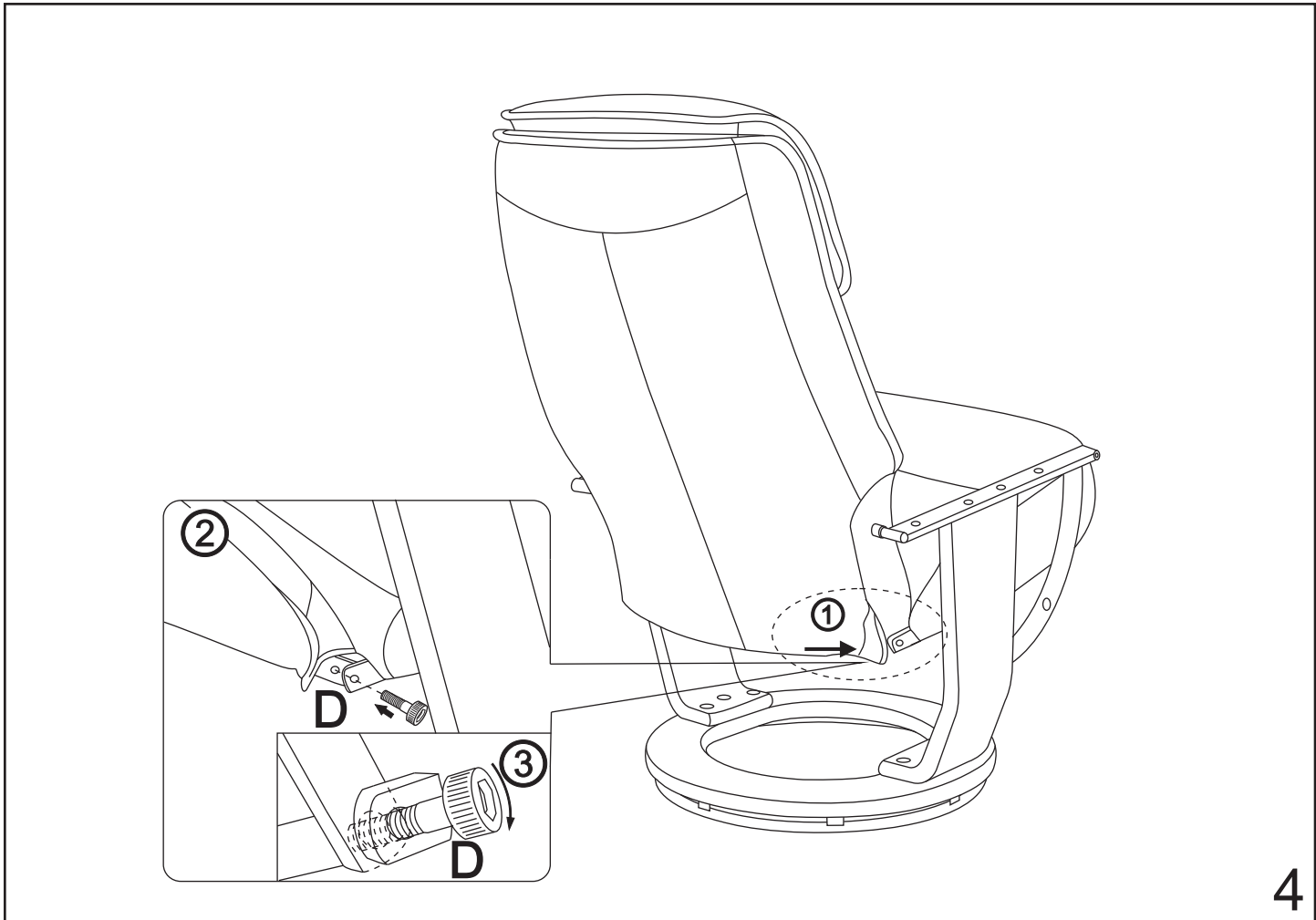

4

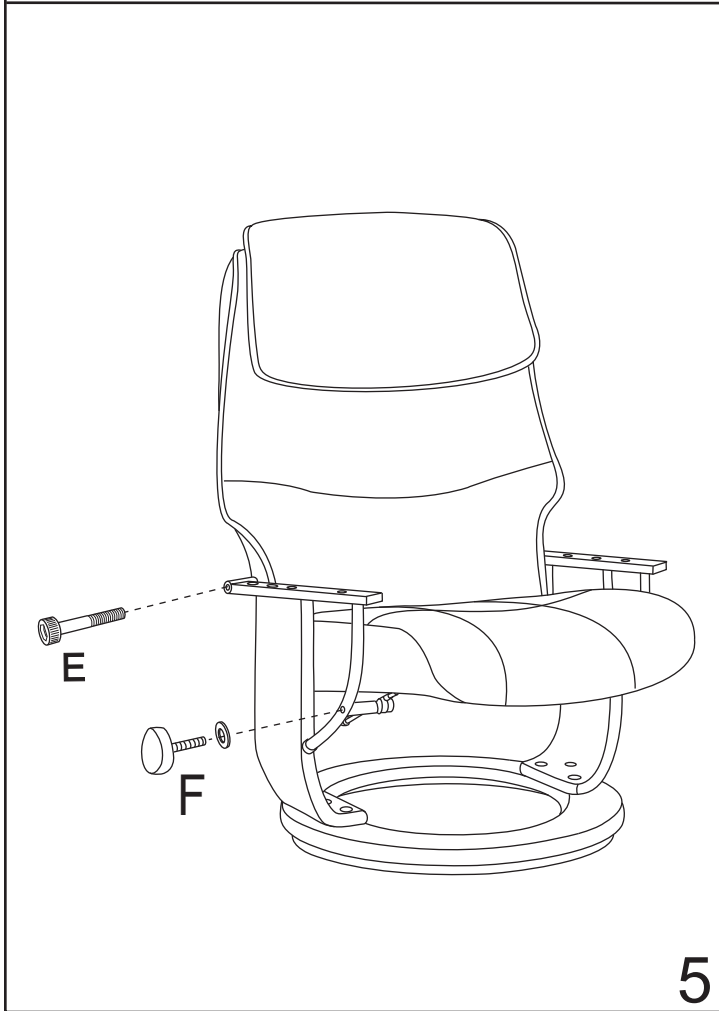

5

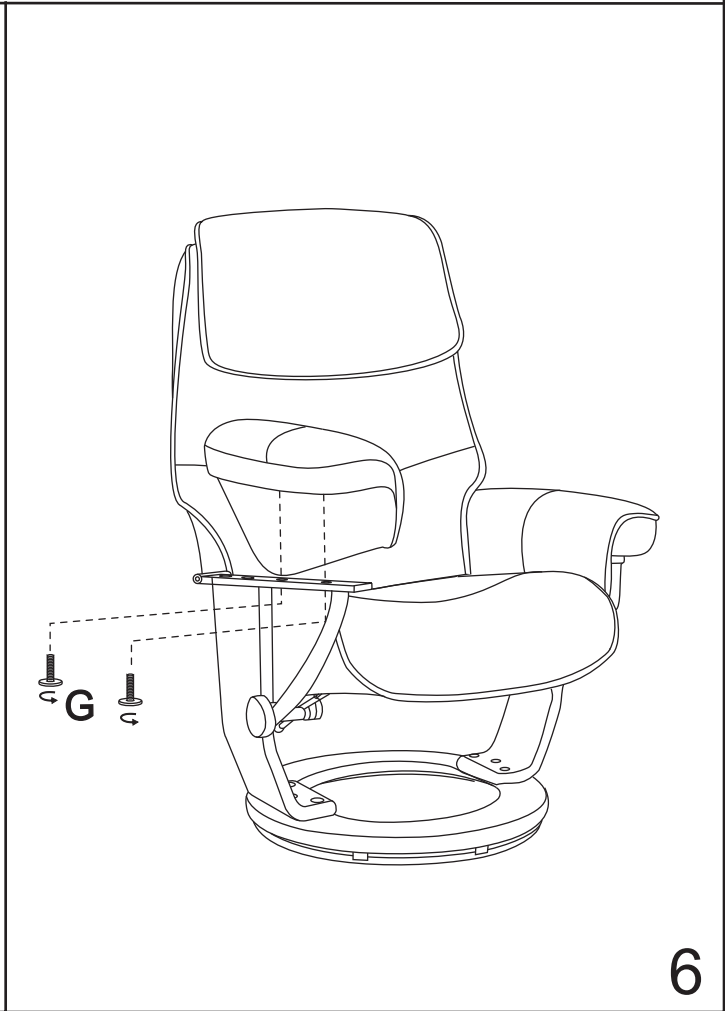

6